



Downtown Spa

by aquatica®

Pre-Installation Manual

Contents

1	MEASUREMENTS AND TECHNICAL SPECIFICATIONS	?
	Temporary positioning	?
2	WHAT PREPARATIONS ARE REQUIRED?	?
3	IDENTIFICATION OF THE INSTALLATION SITE	?
	Outdoor installation	?
	Indoor installation	?
4	PREPARATION OF THE INSTALLATION SITE	?
	Freestanding installations	?
	Recessed installations	?
5	PLUMBING PREPARATIONS	?
	Tap water and well water	?
	Water hardness	?
	Water alkalinity	?
	Characteristics of the water supply	?
6	ELECTRICAL PREPARATIONS	?

1: MEASUREMENTS & TECHNICAL SPECIFICATIONS

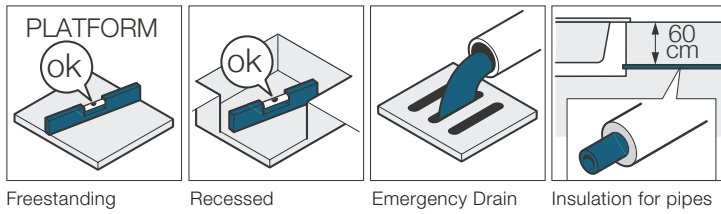

Freestanding Recessed Emergency Drain Insulation for pipes

The manufacturer suggests a minimum load of 485 kg/m².

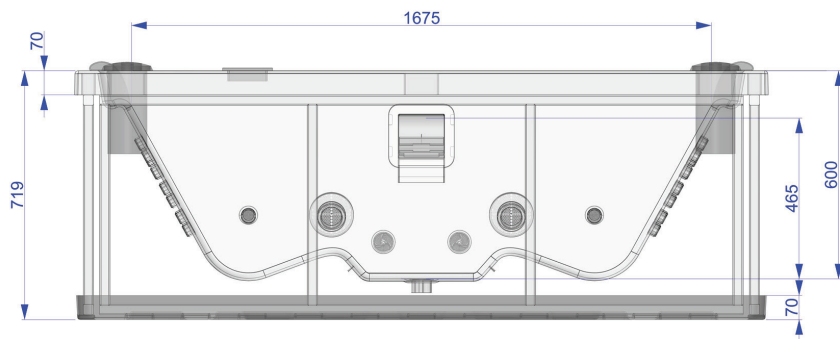
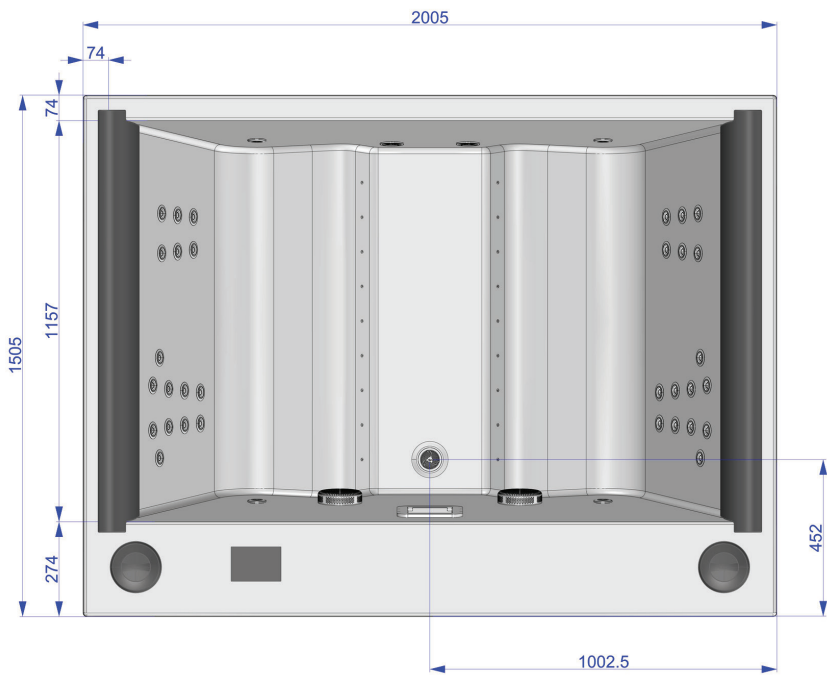

Maximum water content	520 liters
Weight with water	740kg
Weight when empty	220kg
Voltage	220V
Amperes	20A
Whirlpool pump motor	2x2 HP
Recirculation motor	1/15 HP
Heating	4kW
Operating temperature	-5°C ~ +45°C

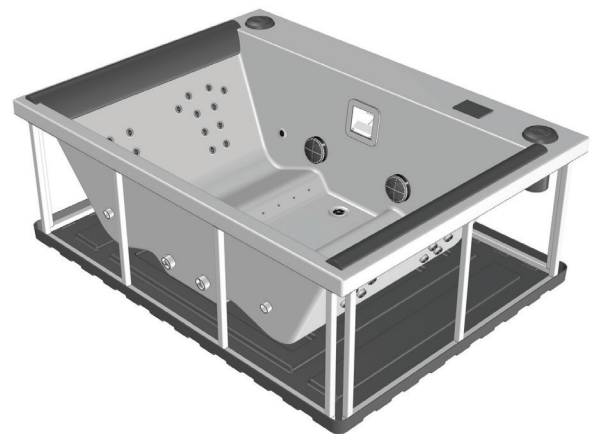

Downtown Spa by aquatica®

The spa works efficiently and safely if it is installed correctly and in compliance with the regulations in country of use.

This pre-installation guide provides information for a proper preparation of the environments and the plumbing and electrical connections. This allows for a quick and safe installation.

The pre-installation stages involve the following professionals:

- A construction engineer for the calculation of the loading capacity of the platforms or floors.
- A qualified and certified company that will prepare the installation site according to the instructions provided in this guide, following current work safety regulations.
- Certified and qualified electrician and plumber who prepare electrical and plumbing systems in compliance with local and national regulations regarding civil and industrial systems.

The user must promptly notify the professionals of any existing underground obstacles like gas or water lines and electrical or telephone cables.

Upon completion of pre-installation all these specialists must issue a declaration of conformity of the systems installed. Without such document, Aquatica declines any responsibility for damage to the systems or premises where the spa will be installed.



We recommend checking with the appropriate municipal authorities to see if there are constraints that prevent installation or if permits might be required.



An incorrect pre-installation could cause structural damage to the spa and void the warranty.

TEMPORARY POSITIONING



The installation of the minipool should be done immediately upon receipt.

In any case, once unpacked, if it is necessary to temporarily place it on a surface awaiting the installation, it will be necessary to place level concrete slabs having a minimum thickness of 5 cm (2") under the entire bottom of the spa. **Since the temporary base may shift, it is recommended to leave the minipool in that position for the shortest possible time.**

Do not leave the empty minipool in DIRECT SUNLIGHT. The surface temperature could rise above 80°C (176F) resulting in serious damage, including cavitation and the deformation of the surface and components. Damage caused by direct exposure to sunlight is not covered by the warranty. In such conditions place a cover (fixed or mobile) to protect your spa unit.

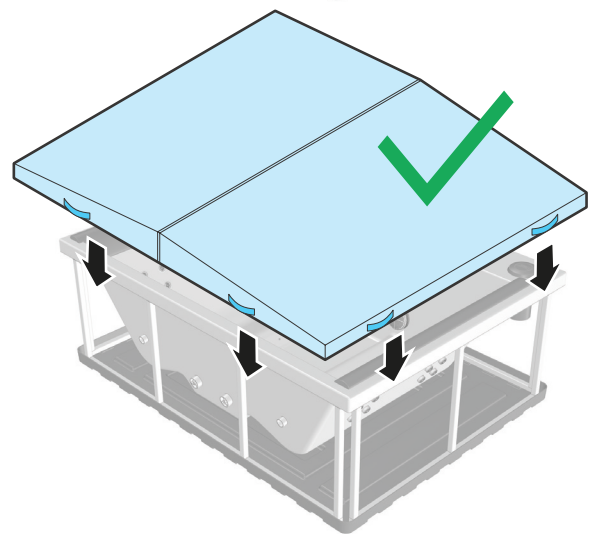
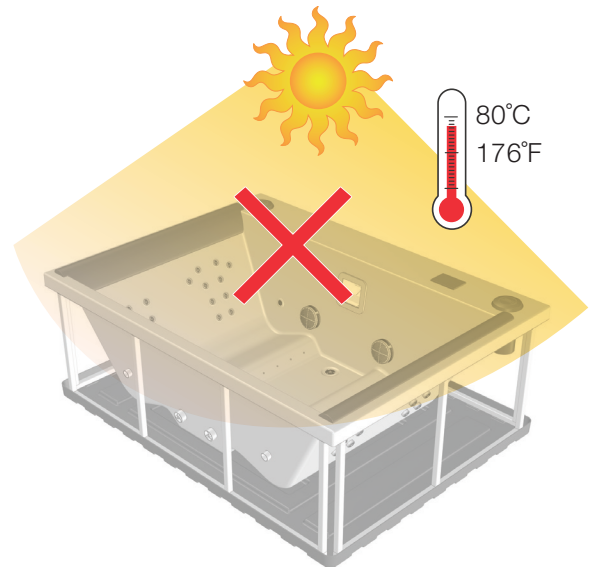

Please note

Aquatica cannot be held responsible and **does not recognize the warranty** in the case of:

- **Installations or connections that are not compliant** or that are carried out without following the national regulations concerning civil and industrial installations.
- **Pre-installation and installation carried out by unqualified personnel** or otherwise not in compliance with the instructions in the preinstallation and installation manuals.
- **Incorrect preparation of the installation environments**, including the supporting surface.
- Accidents and damage due to a non-compliant installation or use of the bathtub.
- **Masonry works** that prevent the removal and handling of the minipool or defective parts thereof.

2: WHAT PREPARATIONS ARE REQUIRED?

To be installed, the minipool requires:

- 1 Identification of the installation site.
- 2 Preparation of the installation site.
- 3 Preparation of the plumbing.
- 4 Preparation of the electrical system.
- 5 A possible external heat exchanger (optional), see next page for details.

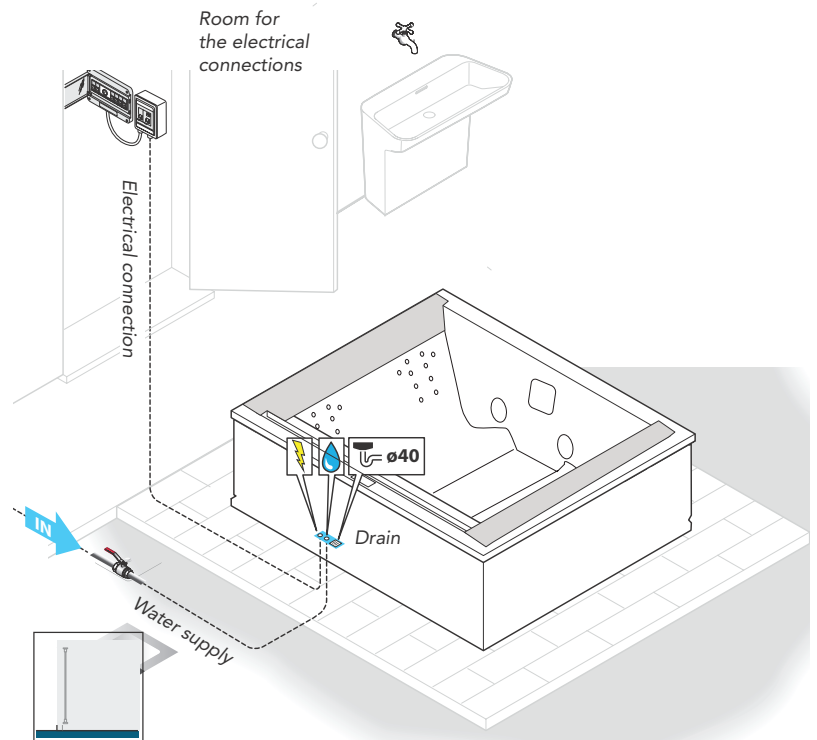

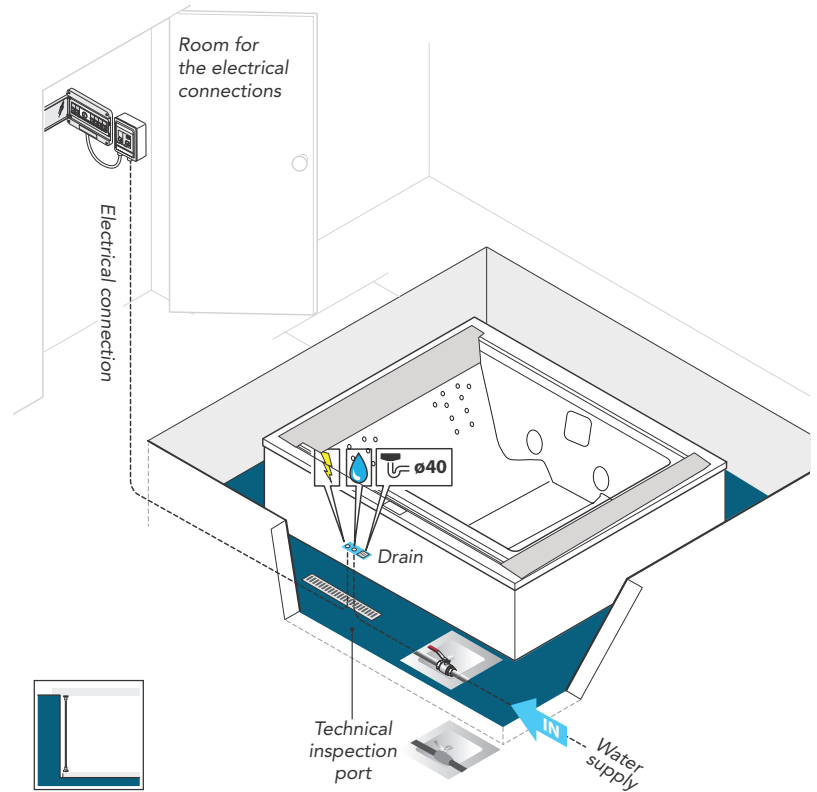

The following pages will provide detailed explanations of how to perform these preparations.

EXAMPLES OF OUTDOOR/INDOOR SPA INSTALLATION.



3: IDENTIFICATION OF THE INSTALLATION SITE

 When choosing the position, take into account the local regulations that prohibit any electrical installation (plug sockets, switches, lamps, etc.) in the area surrounding the spa for a distance of at least 60 cm (24") and a height of 230 cm (90").

 When choosing the position, bear in mind that the inspection side (electrical/plumbing components side) must always remain accessible for future maintenance.

The recommended ambient temperature for the bathtub must be between -5°C and 45°C (23-113F), with a relative humidity of 20-80%.

OUTDOOR INSTALLATION

Take into account the proximity of trees or hedges, and note that debris (e.g., leaves) can cause damage to the equipment over time that is not covered by warranty and make maintenance more expensive and frequent.

Also assess the best position to safeguard privacy and respect for others, as well as the best view or climatic position consistent with local regulations.

A sunny area with increased exposure during the morning ensures greater well-being for users!

 Consider the geological composition of the soil on which the supporting platform will be built. Soils that are very sandy, permeable or subject to flooding could compromise the durability of the minipool's support platform.

INDOOR INSTALLATION

Note that the evaporation of water in the minipool in the presence of high internal temperatures can generate very high levels of humidity in the environment.

To overcome this drawback, choose an environment with good natural or forced ventilation. As an alternative, install a dehumidification system. Humidity damage is not covered by the manufacturer warranty.

 Take into account the size of the minipool: narrow passages, doors and steps can be an obstacle to its transport to the desired place.

 Before preparing the supporting surface, see the sections on the plumbing and electrical connections for positioning the connections correctly.

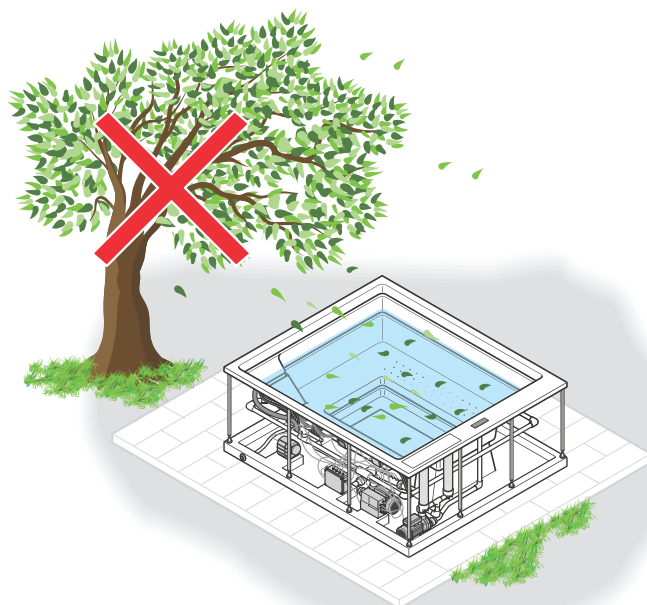

Please note

Our spas are built to be positioned outdoors.

If you install the spa indoors, remember that it must be able to be easily inspected or moved for any ordinary and extraordinary maintenance operations.

4: PREPARATION OF THE INSTALLATION SITE

FREESTANDING INSTALLATIONS

As a base, build a platform or flooring in reinforced concrete, at least 10 cm thick, perfectly flat and suitable for supporting the weight of the spa and the people using it.

The manufacturer suggests a minimum load of 450 kg/m². In any case contact a qualified construction engineer to calculate the appropriate load for the installation site.



Wedges or shims cannot be placed under the hot tub to level it. Remember to ground the structural reinforcement in accordance with electrical codes.

Prepare:

- A** Drainage grating around the perimeter to help preserve the equipment and the structure (even for indoor installations).
 - B** Non-slip flooring around the minipool.
-  For the preparation of the water and electrical connections see the pertinent section on page 11.

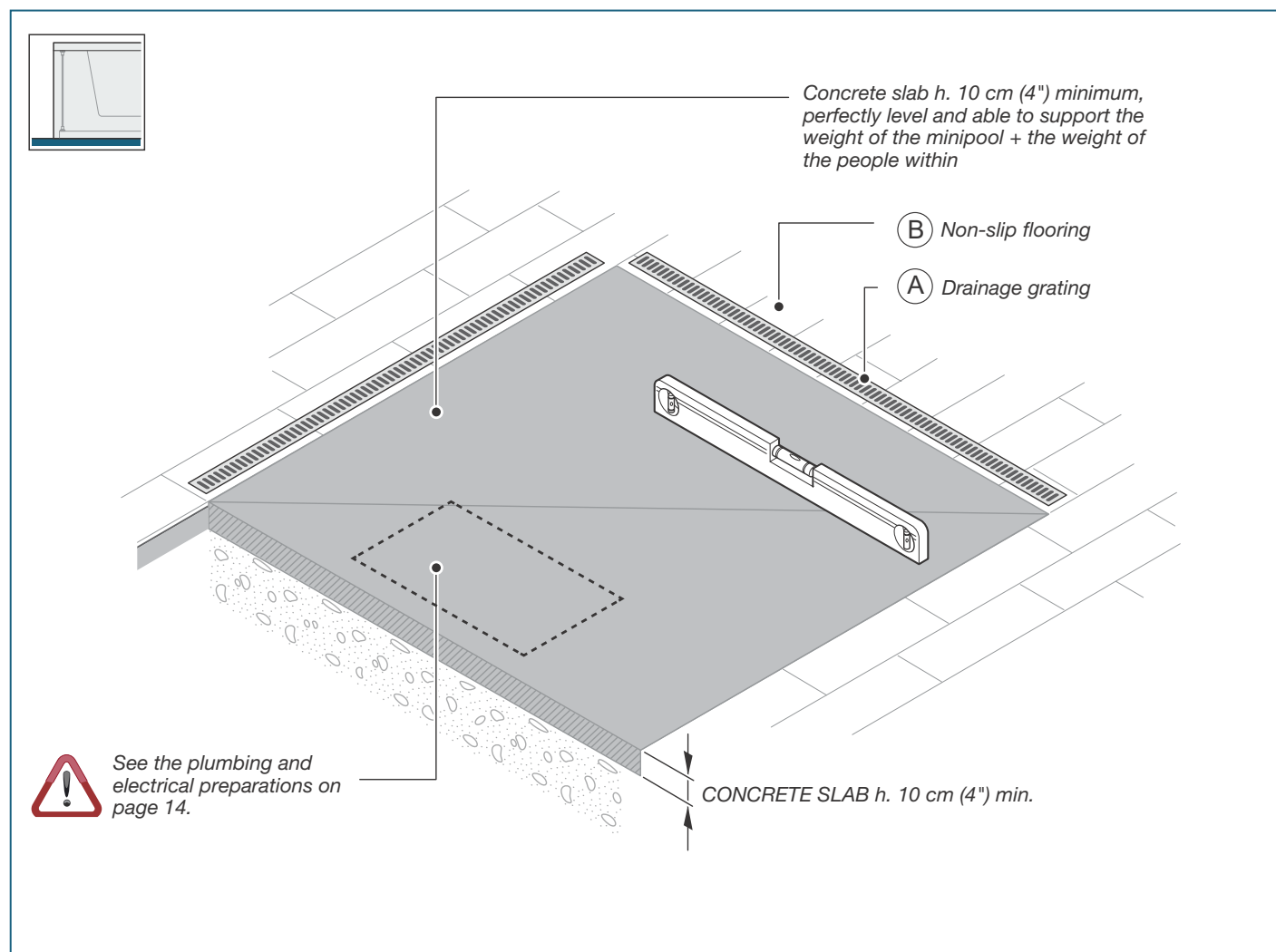

4: PREPARATION OF THE INSTALLATION SITE CONTINUED

RECESSED INSTALLATIONS

As a base, create a reinforced concrete recess having a thickness of at least 10 cm, perfectly flat and able to support the weight of the minipool and the people using it (the Manufacturer recommends a minimum load of 450 kg/m²). In any case contact a qualified construction engineer to calculate the appropriate load for the installation site.

 Wedges or shims cannot be placed under the hot tub to level it. Remember to ground the structural reinforcement in accordance with electrical codes.

 If it was not possible to provide a technical inspection port on all sides of the minipool, a pneumatic lift is available (OPTIONAL - to be requested from the Manufacturer) in order to simplify future maintenance operations.

It is recommended to provide a removable inspection hatch "A" positioned on the side where the bathtub components are situated.

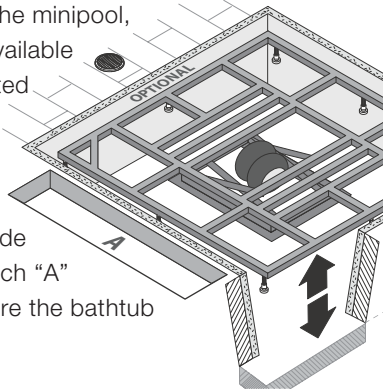

Prepare:

- A** A technical inspection port at least 50 cm wide on all sides of the minipool. This will make future maintenance or repairs easier.
- B** Drainage grating around the perimeter and in the recess to help preserve the equipment and the structure (even for indoor installations).
- C** A non-slip flooring around the minipool.
- B** Two Ø15 cm (6") vents to ensure proper ventilation and extraction of the heat and moisture from the technical compartment.

FOR RECESSED OUTDOOR INSTALLATIONS, to avoid damage due to freezing we recommend insulating

- E** the minipool recess. This procedure prevents excessive condensation that over time cause odours and damage to all major internal components. The choice of materials and thickness should be based on the minimum temperatures reached in the country of installation.

 For the preparation of the water and electrical connections see the pertinent section on page 11.

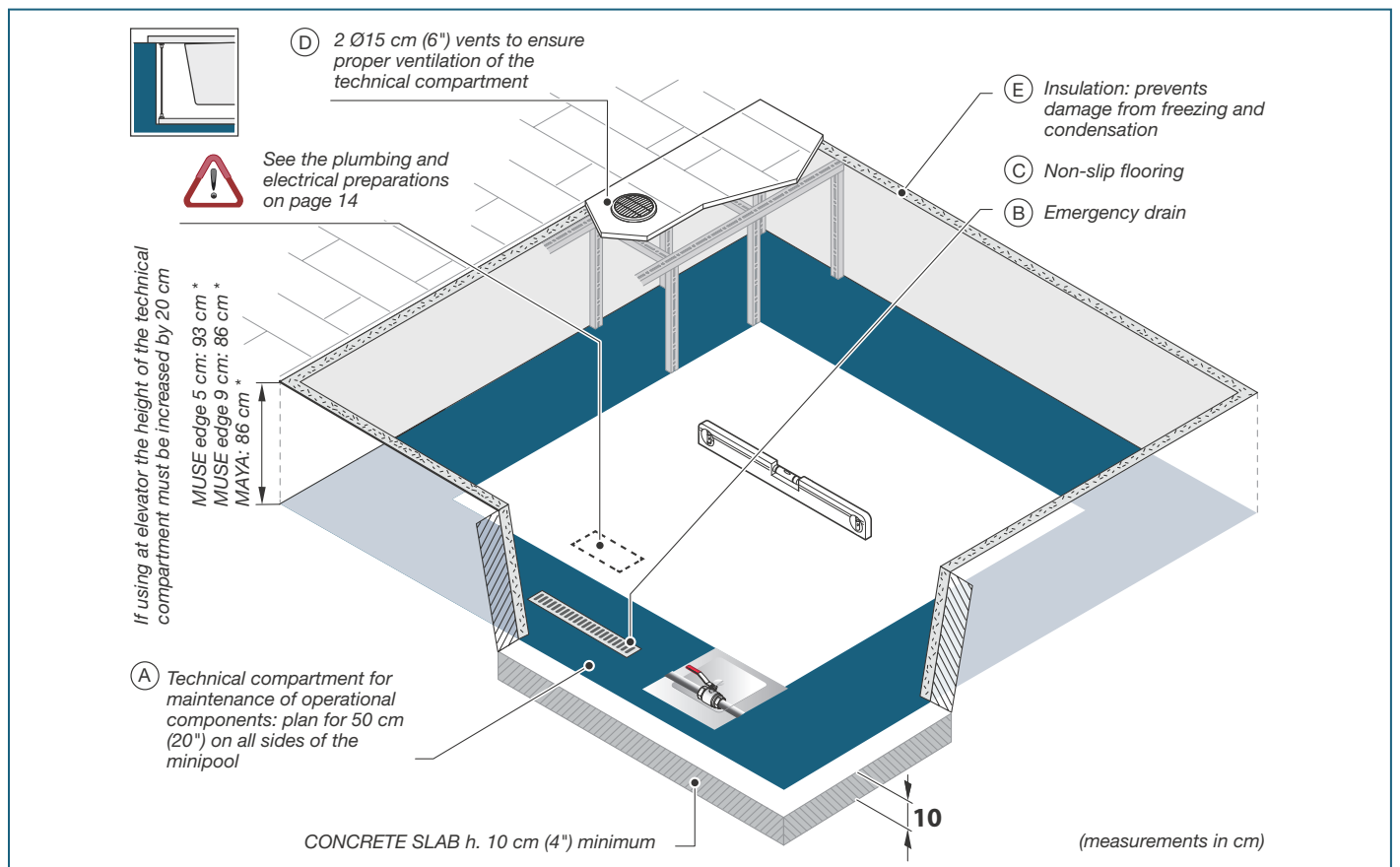

More information

TAP WATER AND WELL WATER

To ensure maximum hygiene and durability of the minipool it is essential to pay close attention to the quality of the water that will be used to fill it. It is important that the water used be drinkable. It is always advisable not to use well water because it may be very hard, rich in metals like iron and manganese, and have bacterial loads.

Tap water is recommended. In the case of very hard or ferrous water it is always recommended to install softening and iron removal systems upstream.

The company cannot be held responsible for issues related to the use of non-drinkable water or lack of installation of such systems.

The plumber is responsible for choosing the type of components to be used and the verification of compliance with the purity and potability parameters of the water supply.

WATER HARDNESS

Water hardness (TH) is determined by the total content of calcium and magnesium present in the water, coming from their soluble salts.

Water classification:

.....up to 7°F = Very soft water

From 7°F to 14°F = Soft water

From 14°F to 22°F = Slightly hard water

From 22°F to 32°F = Fairly hard water

From 32°F to 54°F = Hard water

more than 54°F = Very hard water

(1°F = 10 mg calcium carbonate per litre of water)

WATER ALKALINITY

Alkalinity (CAT) represents the concentration of bicarbonate ions present in the water. It is expressed as mg/L of calcium carbonate or in French degrees (°F). Ideal values of alkalinity range between 80 mg/L and 125 mg/L (8°F- 12.5°F). Values outside of this range can more easily cause variations of the pH. Instead, alkalinity within the range noted makes it possible to “buffer” the pH value, resulting in fewer abrupt variations.

WATER PH

What is pH?

The pH is a chemical parameter that gives an idea of the acidity or basicity of the water. It can assume values between 0 and 14. By definition water is considered neutral if its pH is equal to 7. It is acidic if the pH is lower than 7 and basic if the pH is greater than 7. Disinfectants have an ideal pH at which they are most effective.

In the case of heated water treated with bromine products it is recommended to keep the pH value in the range from 7.4 to 7.8 using chemical correctors as needed if the pH is higher or lower to bring the the pH value back to the recommended interval.

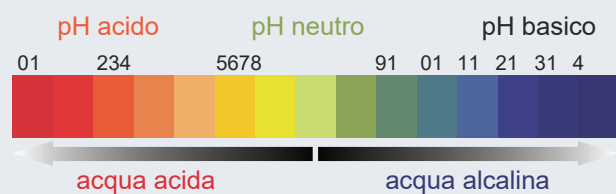

6: ELECTRICAL PREPARATIONS

Downtown Spa by Aquatica

Bond in accordance with national and local codes.

Open bonding lugs are located at the top of the junction box.

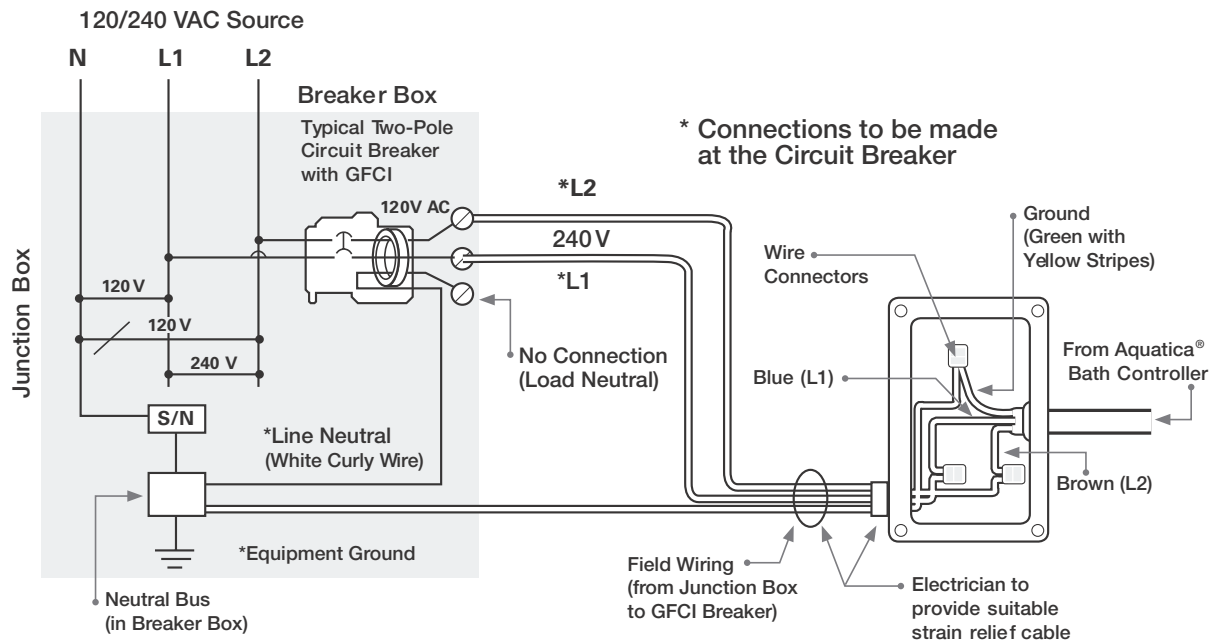

Make the Electrical Connections

IMPORTANT!

The Aquatica® Spa series hydromassage bathtubs come equipped with a wiring junction box and are designed to operate between 208 VAC and 240 VAC at either 50 Hz or 60 Hz.

IMPORTANT!

While the Aquatica® Bath Controller is designed to operate between 208 VAC and 240 VAC at either 50 Hz or 60 Hz, the pumps are market specific and require the correct frequency that is applicable for your specific market. Our US/Canadian Spa series bathtubs ship with 60Hz pumps, while our International models ship with 50Hz pumps.

WARNING!

Risk of electrical shock. Make sure the power has been disconnected before performing the following procedures. Refer to the "Important Information" section.

WARNING!

Risk of electrical shock. To reduce the risk of electrical shock, connect the system to properly grounded Ground-Fault Circuit-Interrupter (GFCI) or Earth-Leakage Circuit-Breaker (ELCB). This will provide additional protection against line-to-ground shock hazard. One 208-240V, 20A for bathtubs or 30A for spas, 50/60Hz dedicated circuit is required.

IMPORTANT!

The load neutral is not used. There should be no connection to the load neutral terminal on the Ground-Fault Circuit-Interrupter (GFCI) breaker. The green wire with the yellow stripes is the equipment ground and needs to be connected to the neutral bus in the main circuit breaker box.

- The Aquatica® Bath Controller, pumps, blower, lights and heater have been pre-wired at the factory. A licensed electrician should make a routine service connection to the junction box.
- Connect service to the junction box. The junction box contains blue, brown, and green with yellow stripe colored wires.
- Follow local electrical codes. Bond in accordance with national and local codes.
- A wiring harness has been pre-wired at the factory, allowing communication between the junction box, 60 cm (23.75") x 230 cm (90.5") and the Aquatica® Bath Controller. No additional wiring is required, but ensure that all wires are securely fastened.

aquatica®

Function : Form : Fashion

aquaticausa.com | aquaticabath.ca | aquaticabath.co.uk | aquaticabath.eu